

The Charles

Cedar Cottage

Plan A

3 Bedroom + Den + Flex + 2.5 Baths
 Total 1,426 s.f.
 1341 & 1355 E21st Ave

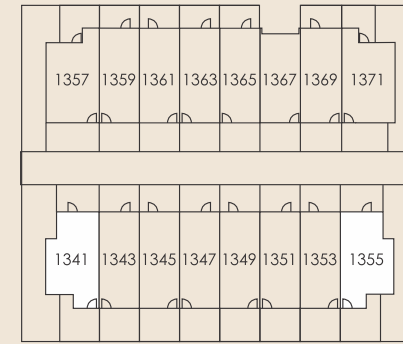

East 21st Ave

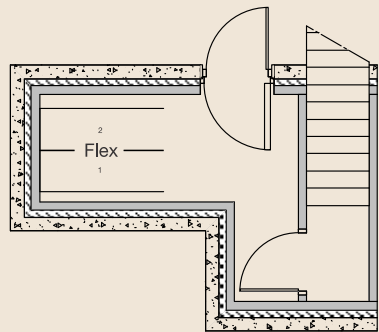

Direct access to home

PARKADE LEVEL
 165 s.f.

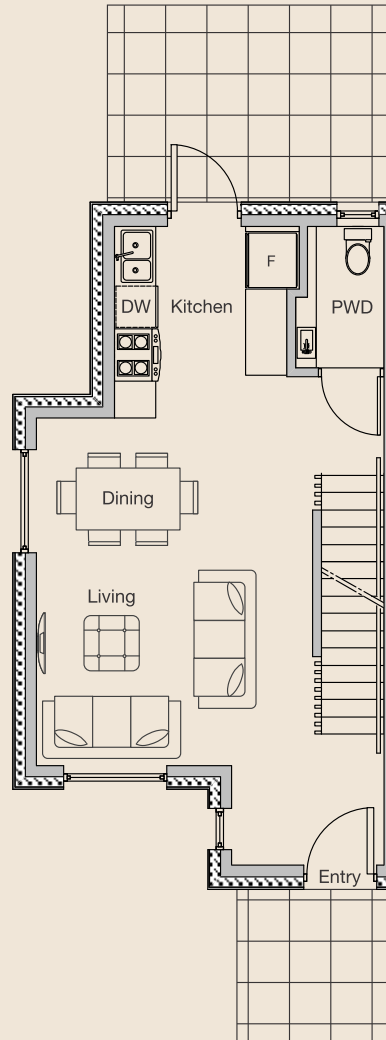

GROUND LEVEL
 487 s.f.
 Front Porch 50 s.f.
 Back Porch 130 s.f.

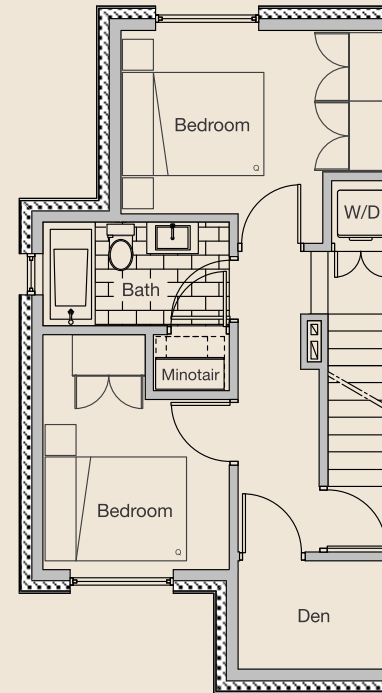

SECOND LEVEL
 487 s.f.

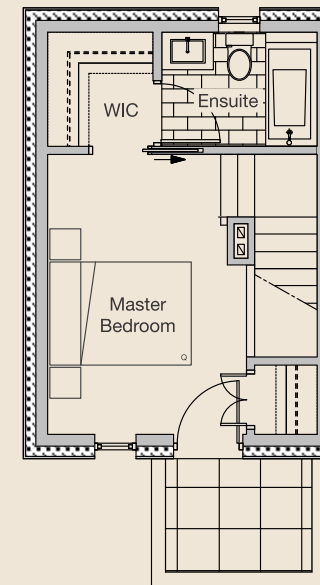

THIRD LEVEL
 287 s.f.
 Top Deck 43 s.f.

The Charles

Cedar Cottage

Plan B

3 Bedroom + Den + Flex + 2.5 Baths
 Total 1,396 s.f.

1343, 1345, 1347, 1349, 1351 & 1353 E21st Ave

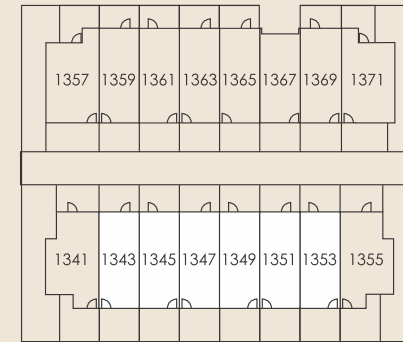

East 21st Ave

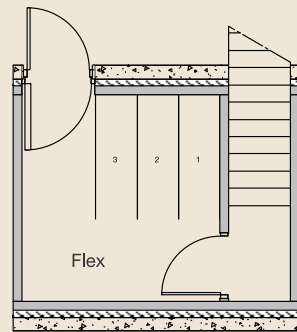

Direct access to home

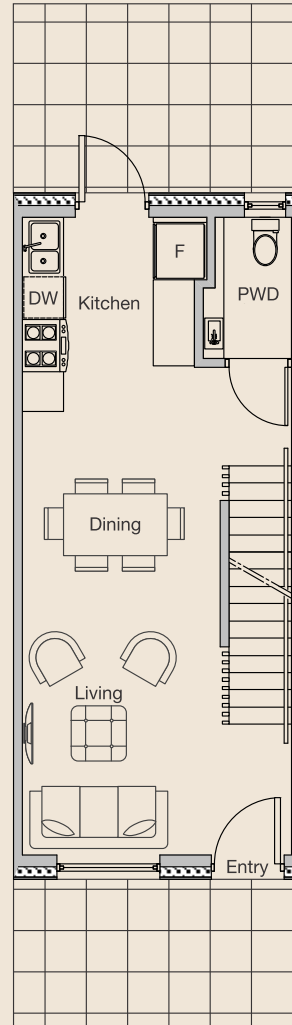

GROUND LEVEL
 442 s.f.
 Front Porch 96 s.f.
 Back Porch 134 s.f.

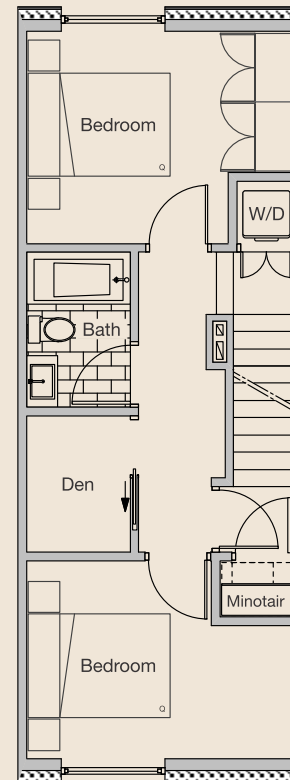

SECOND LEVEL
 502 s.f.

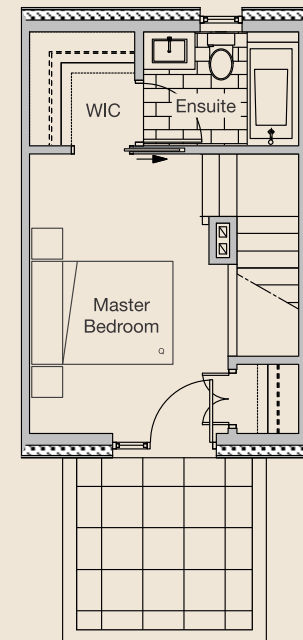

THIRD LEVEL
 284 s.f.
 Top Deck 76 s.f.

Dimensions, sizes, specifications, layouts and materials are approximate only and subject to change without notice. E.&O.E.

The Charles

Cedar Cottage

Plan C

3 Bedroom + Den + Flex + 2.5 Baths
 Total 1,537 s.f.
 1357 & 1371 E21st Ave

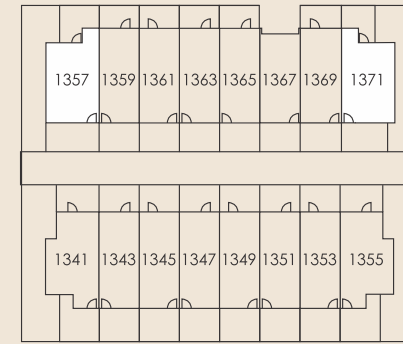

East 21st Ave

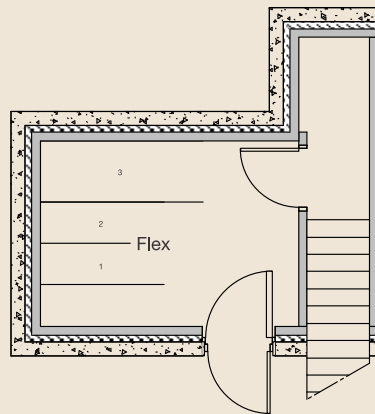

Direct access to home

PARKADE LEVEL
219 s.f.

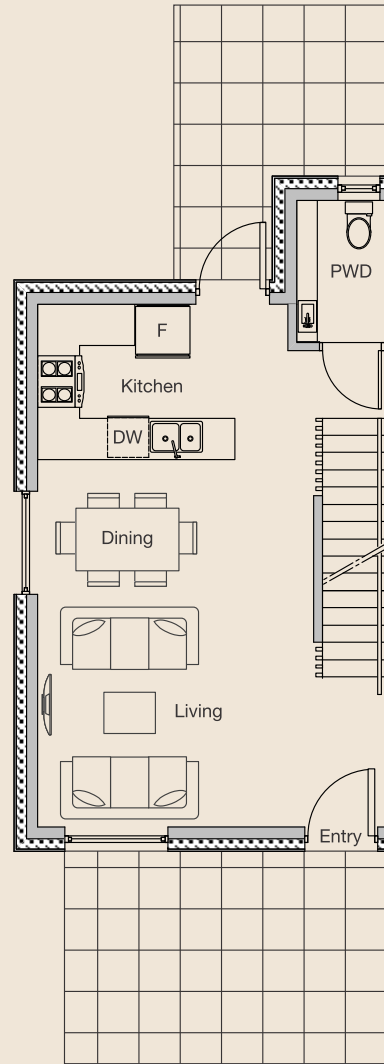

GROUND LEVEL
494 s.f.
Front Porch 156 s.f.
Back Porch 104 s.f.

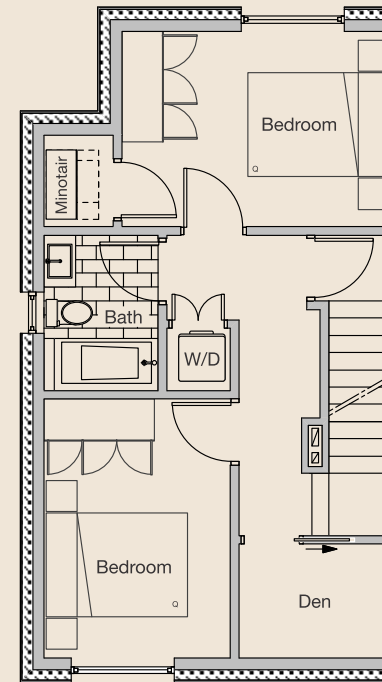

SECOND LEVEL
537 s.f.

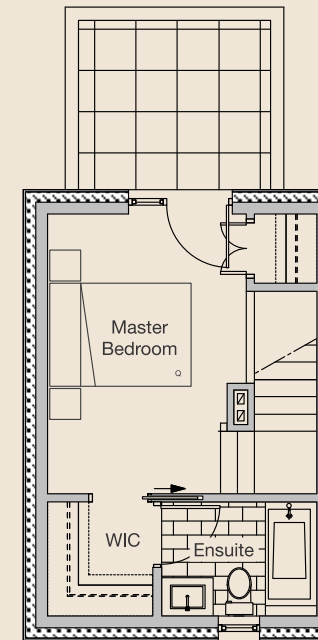

THIRD LEVEL
287 s.f.
Top Deck 80 s.f.

The Charles

Cedar Cottage

Plan D

3 Bedroom + Den + Flex + 2.5 Baths

Total 1,419 to 1,429 s.f.

1359, 1361, 1363, 1365 & 1369 E21st Ave

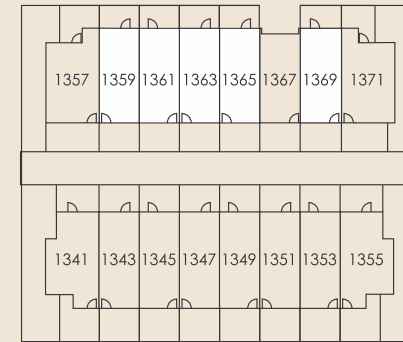

East 21st Ave

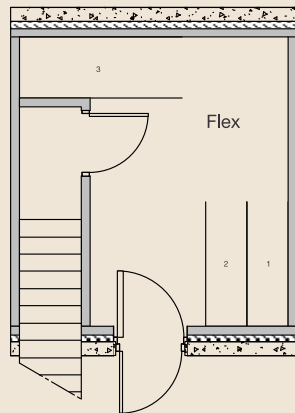

Direct access to home

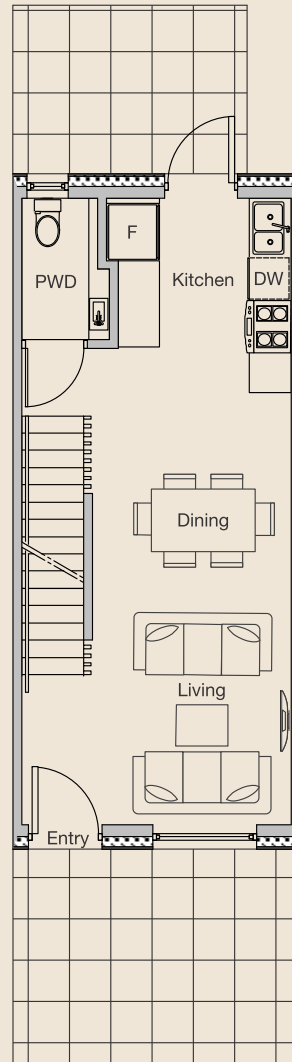

GROUND LEVEL

434 s.f.

Front Porch 151 s.f.
Back Porch 86 s.f.

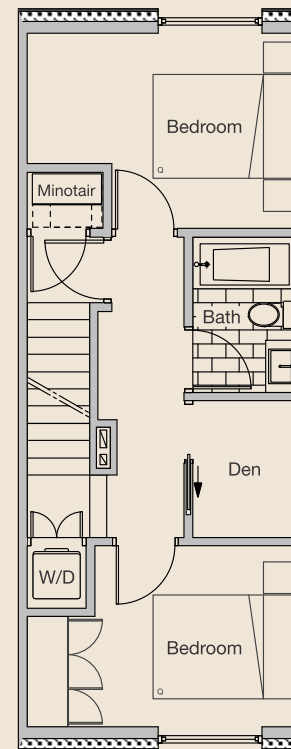

SECOND LEVEL

479 s.f.

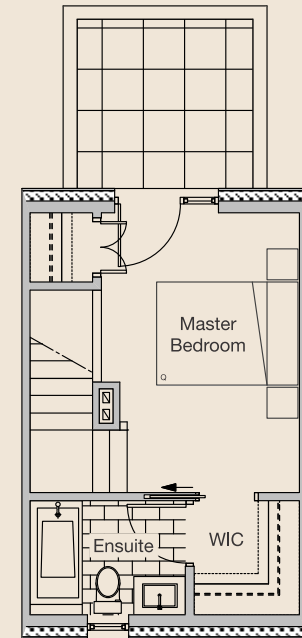

THIRD LEVEL

287 s.f.

Top Deck 74 s.f.

PARKADE LEVEL

228 s.f.

The Charles

Cedar Cottage

Plan E

2 Bedroom + Den + 1.5 Baths
 Total 893 s.f.
 1367 E21st Ave

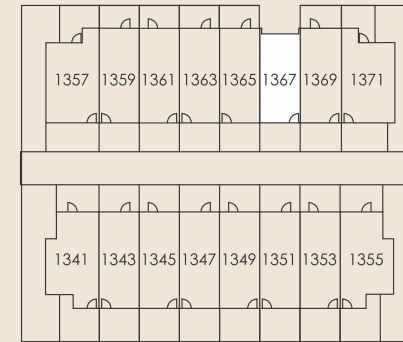

East 21st Ave

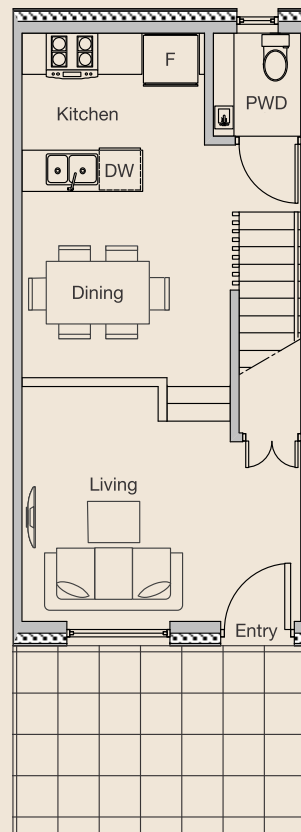

GROUND LEVEL
 423 s.f.
 Front Porch 136 s.f.

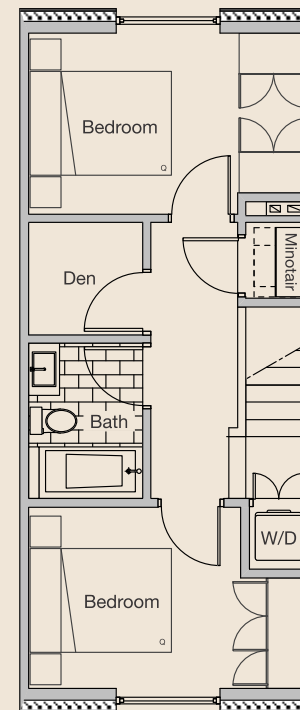

SECOND LEVEL
 470 s.f.